

## BOARD OF APPEALS

May 13, 2026

County Administration Building, 100 W. Washington St., Meeting Room 2000, Hagerstown, at 6:00 p.m.

### AGENDA

**AP2026-012:** An appeal was filed by AutoZone Development LLC for a variance from the required 25 ft. setback from the road right-of-way to 22.34 ft., more or less, for installed freestanding sign on property owned by Sharpsburg Holding LLC and located at 10301 Ezra Drive, Hagerstown, Zoned Highway Interchange District. **-POSTPONED TO THE JULY 8, 2026 HEARING**

**AP2026-013:** An appeal was filed by The W House of Hagerstown Foundation Inc., a request for a special exception on the basis that a transitional/sheltered care facility is functionally similar to the principal permitted use of an assisted living facility, nursing/convalescent home on property owned by HBC LLC and located at 18618 Crestwood Drive, Hagerstown, Zoned Business Local District. **-GRANTED**

---

Pursuant to the Maryland Open Meetings Law, notice is hereby given that the deliberations of the Board of Zoning Appeals are open to the public. Furthermore, the Board, at its discretion, may render a decision as to some or all of the cases at the hearing described above or at a subsequent hearing, the date and time of which will be announced prior to the conclusion of the public hearing. Individuals requiring special accommodations are requested to contact Katie Rathvon at 240-313-2464 Voice, 240-313-2130 Voice/TDD no later than May 4, 2026. Any person desiring a stenographic transcript shall be responsible for supplying a competent stenographer.

The Board of Appeals reserves the right to vary the order in which the cases are called. Please take note of the Amended Rules of Procedure (Adopted July 5, 2006), Public Hearing, Section 4(d) which states:

Applicants shall have ten (10) minutes in which to present their request and may, upon request to and permission of the Board, receive an additional twenty (20) minutes for their presentation. Following the Applicant's case in chief, other individuals may receive three (3) minutes to testify, except in the circumstance where an individual is representing a group, in which case said individual shall be given eight (8) minutes to testify.

Those Applicants requesting the additional twenty (20) minutes shall have their case automatically moved to the end of the docket.

For extraordinary cause, the Board may extend any time period set forth herein, or otherwise modify or suspend these Rules, to uphold the spirit of the Ordinance and to do substantial justice.

Tracie Felker, Chairman

Board of Zoning Appeals



WASHINGTON COUNTY BOARD OF ZONING APPEALS

747 Northern Avenue | Hagerstown, MD 21742-2723 | P:240.313.2430 | F:240.313.2431 | Hearing Impaired: 7-1-1

ZONING APPEAL

Property Owner: Sharpsburg Hilding LLC
1741 Dual Highway
Suite B
Hagerstown MD 21740
Appellant: AutoZone Development LLC
10301 Ezra Drive
Hagerstown MD 21740
Docket No: AP2026-012
Tax ID No: 10067468
Zoning: HI
RB Overlay: No
Zoning Overlay:
Filed Date: 04/17/2026
Hearing Date: 05/13/2026

Property Location: 10301 Ezra Drive
Hagerstown, MD 21740

Description Of Appeal: Variance from the required 25 ft. setback from the road right-of-way to 22.34 ft., more or less, for installed freestanding sign.

Appellant's Legal Interest In Above Property: Owner: No Contract to Rent/Lease: No
Lessee: Yes Contract to Purchase: No
Other:

Previous Petition/Appeal Docket No(s): AP2020-011, AP2025-008
Applicable Ordinance Sections: Washington County Zoning Ordinance Section 22.23 (e)

Reason For Hardship: See justification statement

If Appeal of Ruling, Date Of Ruling:

Ruling Official/Agency:

Existing Use: Freestanding Sign Proposed Use:
Previous Use Ceased For At Least 6 Months: Date Ceased:
Area Devoted To Non-Conforming Use - Existing: Proposed:

I hereby affirm that all of the statements and information contained in or filed with this appeal are true and correct.

[Handwritten signature]

Appellant Signature

State Of Maryland, Washington County to-wit:

Sworn and subscribed before me this 17 day of April, 2026.

Nov. 7, 2029
My Commission Expires

[Handwritten signature]
Notary Public

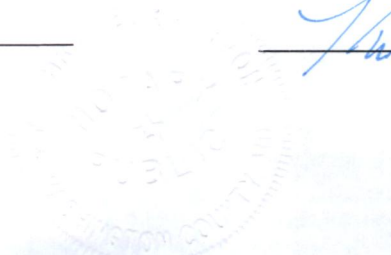



WASHINGTON COUNTY BOARD OF ZONING APPEALS

747 Northern Avenue | Hagerstown, MD 21742-2723 | P:240.313.2430 | F:240.313.2431 | Hearing Impaired: 7-1-1

**AFFIDAVIT IN COMPLIANCE WITH SECTION 25.51(C)**

Docket No: AP2026-012

**State of Maryland Washington County, To Wit:**

On 4/17/2026, before me the subscriber, a Notary of the public of the State and County aforesaid, personally appeared William Wantz and made oath in due form of law as follows:

William Wantz will post the zoning notice sign(s) given to me by the Zoning Administrator in accordance with Section 25.51(c) of the Washington County Zoning Ordinance for the above captioned Board of Appeals case, scheduled for public hearing on 05/13/2026, and that said sign(s) will be erected on the subject property in accordance with the required distances and positioning as set out in the attached posting instructions.

Sign(s) will be posted on 04/28/2026 and will remain until after the above hearing date.

\_\_\_\_\_

**William Wantz**

Sworn and subscribed before me the day and year first above written.

\_\_\_\_\_

**Notary Public**

\_\_\_\_\_

**My Commission Expires**

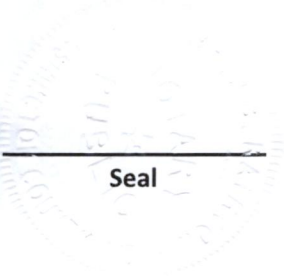

Seal



## BOARD OF ZONING APPEALS

### ATTENTION!

### Posting Instructions

The premises MUST be posted in accordance with the following rules:

1. The sign must be posted a minimum of fourteen (14) days prior to the public hearing  
Section 25.51(c) Property upon which the application or appeal is concerned shall be posted conspicuously by a zoning notice no less in size than twenty-two (22) inches by twenty-eight (28) inches at least fourteen (14) days before the date of the hearing.
2. The sign must be placed on the property within ten (10) feet of the property line which abuts the most traveled public road.
3. The sign must be posted in a conspicuous manner not over six (6) feet above the ground level, and affixed to a sturdy frame where it will be clearly visible and legible to the public.
4. The sign shall be maintained at all times by the applicant until after the public hearing. If a new sign is needed or required, please contact the Plan Review Department at 240-313-2460.
5. An affidavit certifying the property will be posted for the minimum of fourteen (14) days prior to the public hearing date.

Proper posting of the sign will be spot checked by the Zoning Inspector. IF SIGN IS NOT IN COMPLIANCE, IT MAY RESULT IN RESCHEDULING OF THE HEARING.





**BOARD OF ZONING APPEALS**

747 Northern Avenue | Hagerstown, MD 21742 | P: 240.313.2430 | F: 240.313.2461 | Hearing Impaired:

7-1-1 WWW.WASHCO-MD.NET

**Appeal for Variance**

Appeal is hereby made for a variance from a requirement of the Washington County Zoning Ordinance as follows:

Location 10301 Ezra Drive, Hagerstown MD 21740

Appellant's present legal interest in above property: (Check One)

Owner (Including Joint Ownership)     Lessee     Contract to rent/lease  
 Contract to Purchase     Other \_\_\_\_\_

Specify the Ordinance section and subsection from which the variance is desired:  
Section 22.22(e)

Specify the particular requirement(s) from which a variance is desired in that section or subsection:  
"... no part of the supporting structure is less than twenty-five (25') feet from the street right-of-way, ..."

Describe the nature and extent of the desired variance from Ordinance requirements: listed above:  
A dimensional variance of approximately two and one-half feet to five feet is requested.

Describe reason(s) why the Ordinance requirement(s) in question would result in peculiar and/or unusual practical difficulties to or would impose exceptional or undue hardship upon the owner of the property if the requested variance were not granted:

**Provide Detailed Explanation on Separate Sheet**

Has any previous petition or appeal involving this property been made to the Board?  
 Yes     No

If yes, list docket number(s): AP2025-008

I hereby certify that I have, to the best of my knowledge, accurately supplied the information required for the above referenced appeal.

Laura Beth Myers  
Signature of Appellant

c/o William C. Wantz, 123 W. Washington St.,  
Hagerstown MD 21740  
Address and of Appellant

laurabeth.myers@autozone.com  
Email of Appellant

\_\_\_\_\_  
Phone Number of Appellant

This appeal form is to be used to assist the customer in gathering the information necessary to submit an application. However, the application shall be processed in person.

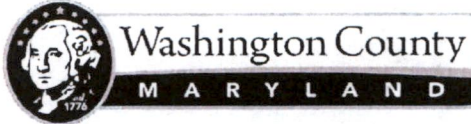

**BOARD OF ZONING APPEALS**

**OWNER REPRESENTATIVE AFFIDAVIT**

This is to certify that AutoZone Development LLC, c/o William C. Wantz, attorney for Applicant  
is authorized to file an appeal with the Washington County Board of Appeals for  
a variance \_\_\_\_\_ on property  
located 10301 Ezra Drive, Hagerstown MD 21740  
The said work is authorized by Sharpsburg Pike Holding, LLC  
the property owner in fee.

**PROPERTY OWNER**

Sharpsburg Pike Holding, LLC

Name

1741 Dual Highway, Ste B

Address

Hagerstown MD 21740

City, State, Zip Code

  
Owner's Signature

Sworn and subscribed before me this 5<sup>th</sup> day of February, 2026

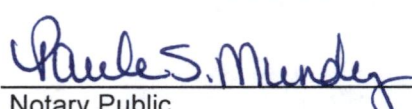
  
Notary Public

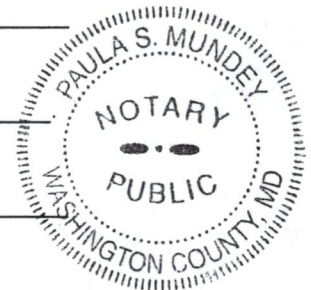

My Commission Expires: 3-18-27

**AUTHORIZED REPRESENTATIVE**

William C. Wantz

Name

123 West Washington Street

Address

Hagerstown MD 21740

City, State, Zip Code

  
Authorized Representative's Signature

Sworn and subscribed before me this 5<sup>th</sup> day of February, 2026

  
Notary Public

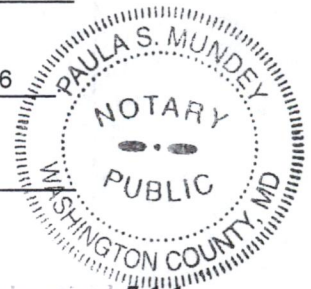

My Commission Expires: 3-18-27

747 Northern Avenue | Hagerstown, MD 21742 | P: 240.313.2430 | F: 240.313.2461 | Hearing Impaired: 7-1-1

APPLICATION OF  
AUTOZONE DEVELOPMENT LLC

MEMORANDUM IN SUPPORT OF ZONING VARIANCE

AutoZone Development LLC, the Applicant ("AutoZone"), by William C. Wantz, its attorney, submits this Memorandum in support of its application for a dimensional area variance based on practical difficulty.

*Background*

The Applicant is a lessee under a commercial lease by and between the Applicant and Sharpsburg Pike Holding, LLC dated February 22, 2021, with respect to real property at 10301 Ezra Drive in Washington County. The land is zoned HI (Highway Interchange) and improved by a newly constructed retail building.

The approved site plan includes an on-premises sign visible from both Ezra Drive and the adjacent right-of-way of the Sharpsburg Pike (MD Rte. 65). The sign was installed for Jones Sign, an independent contractor of the Applicant, by United Sign Group, LLC, the installer.

A worker engaged by United Sign Group encountered significant rock when excavating for the proposed sign. A construction worker probed the surrounding subsurface area and without the involvement or knowledge of the Applicant, departed from the approved site plan and relocated the sign. The actions of the construction worker caused the sign support structure (pole) to be within 25 feet of the right-of-way by approximately 32 inches, contrary to the requirement in §22.23(e) of the Washington County Zoning Ordinance, which provides:

"Individual business or industrial establishments may erect a free-standing business sign, provided the lot frontage is at least forty (40) feet. The free-standing sign shall be located in such a manner that no part of the supporting structure is less than twenty-five (25) feet from the street right-of-way,..." (emphasis supplied)

The mistake was inadvertent.

Relocating the sign to avoid subsurface rock had the unintended effect of placing the sign within 25 feet of the right-of-way line of the Sharpsburg Pike. The pole is 22.34 feet from the right-of-way line of MD Rte. 65. The illuminated sign conforms to the setback requirements of the Ordinance. A variance is required only for the existing location of the supporting pole.

*The 12-Month Rule*

The Washington County Zoning Ordinance includes a rule intended to prevent an applicant from repetitive re-filing of similar zoning applications on the same property:

"Disapproval of Application

If the application is disapproved, thereafter the Board shall take no further action on another application for substantially the same proposal, on the same premises, until after twelve (12) months from the date of such disapproval." *Zoning Ordinance, Washington County, Maryland, §25.7*<sup>1</sup>

AutoZone, the current Applicant, is in possession of the property pursuant to its long-term leasehold interest in the land, and seeks to file its own independent application for a variance based on practical difficulty. AutoZone has not filed or participated in any previous application to the Board of Appeals.

Although the Ordinance precludes the Board from taking action on a second application for 12 months, it does not directly prohibit an action by the Board on an application by a different party, especially when based on real property rights independent of the previous applicant, and presenting different variance grounds. It is not necessary for the Board to delay action in this appeal by this Applicant.

*The Practical Difficulty Standard*

Section 28A of the Washington County Zoning Ordinance defines variance generally as "a relaxation of the terms of the Zoning Ordinance for distance or dimensional requirements." Washington County's Ordinance allows variance relief on the basis of undue hardship or practical difficulty, in the alternative:

Section 25.56 Variances

"A variance may be granted by the Board upon a showing of criteria of practical difficulty or undue hardship described below respectively..."<sup>2</sup>

---

<sup>1</sup> Prior to the filing of this variance appeal, the Applicant's counsel consulted with Jill Baker, the former Planning Director and Zoning Administrator, leading to the filing of this application on behalf of AutoZone without objection.

<sup>2</sup> The Board of Appeals acknowledged that the County's Ordinance allows variance relief based on hardship or practical difficulty, in the alternative. Opinion, AP-2025-008, page 1, *note* 1.

It has been observed in Maryland that sign variances are generally considered under the practical difficulty standard:

"Because a variance from sign regulations is deemed to be an 'area' variance, the impact of which is viewed as being much less drastic than that of a 'use' variance, a party need only show 'practical difficulty,' the lesser standard of proof, to be entitled to relief." *Red Roof Inns, Inc. v. People's Counsel for Baltimore County*, 96 Md. App. 219, 225 (1993)

In Washington County, the three requirements of practical difficulty are set forth in §25.56(A) of the Ordinance:

#### A. Practical Difficulty

1. Strict compliance would unreasonably prevent the use of the property for a permitted purpose or render conformance unnecessarily burdensome;
2. Denying the variances would do substantial injustice to the applicant and a lesser relaxation than that applied for would not give substantial relief; and
3. Granting the variance would observe the spirit of the Ordinance and secure public safety and welfare. *Zoning Ordinance, Washington County, Maryland, §25.56*<sup>3</sup>

Notably, §25.56(A) does not include a self-imposed hardship provision. Instead, the self-created hardship limitation appears only in Section 25.56(B) in the alternative "Undue Hardship" criteria:

#### B. Undue Hardship

\* \* \*

3. The hardship is not the result of the applicant's own actions. *Zoning Ordinance, Washington County, Maryland, §25.7(B)* (emphasis supplied)

---

<sup>3</sup> Section 25.56(A) is in accord with and derived verbatim from Judge Rita Davidson's analysis in *Anderson v. Board of Appeals*, 22 Md.App. 28 (1974); *See also, McLean v. Soley*, 270 Md. 208, 214-215 (1973), quoting 2 Rathkopf, *The Law of Zoning and Planning*, 45-28-29 (3d ed. 1972)

## *Uniqueness*

Maryland's zoning jurisprudence requires that the condition from which variance relief is requested must arise from the property itself, and not from the actions of the Applicant. This requirement is known as "uniqueness", which may include subsurface conditions:

" 'Uniqueness' of a property for zoning purposes requires that the subject property have an inherent characteristic not shared by other properties in the area, *i.e.*, its shape, topography, subsurface condition, environmental factors, historical significance, access or non-access to navigable waters, practical restrictions imposed by abutting properties (such as obstructions) or other similar restrictions." *North v. St. Mary's County*, 99 Md. App. 502, 514 (1994) (emphasis supplied)<sup>4</sup>; *see also*, *King v. Helfrich*, 263 Md. App. 174, 192 (2024), *cert. denied*, 489 Md. 286 (2024); *Cromwell v. Ward*, 102 Md. App. 691, 710 (1995)

In this appeal, the Applicant seeks variance relief from the subsurface condition of the property encountered where the sign was to be installed, as specified in the approved site plan. In the previous decision in AP-2025-008, the Board so observed:

"During construction, the contractor discovered significant rock and the location for the sign was moved to accommodate the topography issue."  
Opinion, AP-2025-008, p.1

In considering the required element of uniqueness, the practical difficulty must relate to a characteristic of the property and not result from the action of the applicant. In this appeal, the practical difficulty was caused by subsurface rock encountered at the excavation site. The installer did not create the practical difficulty. AutoZone did not create the subsurface condition from which it seeks variance relief in this appeal. Instead, the practical difficulty was caused by the subsurface condition of the property.

In previously denying variance relief in AP-2028-008, the Board of Appeals focused on the responsibility of the installer, rather than the practical difficulty inherent in the site, and concluded: "On that basis, the Board is unable to find that a hardship or practical difficulty exists that is related to the inherent characteristics of the property and the application of the setback requirements thereto. *Opinion*, page 3

---

<sup>4</sup> The Board of Appeals quoted the same passage from *North* in its previous Opinion in AP-025-008, at page 2.

Had the Board focused instead on the subsurface condition of the property, the outcome in that appeal might well have been different.

*No Disallowance by Pre-Variance Construction*

The inadvertent relocation of the sign without a variance prior to AP-2025-008 does not preclude variance relief under Maryland law. In *Lewis v. Dep't of Nat. Res.*, 377 Md. 382 (2003), the Court of Appeals of Maryland (now the Supreme Court of Maryland) analyzed an analogous sequence of events involving construction of hunting camp buildings before obtaining a variance, and explained:

"In essence, the issue of petitioner's construction of his six hunting camp buildings prior to his applying for a variance request is a 'red herring.' As previously mentioned, under the County Code and, more importantly, because of the physical characteristics of Phillips Island, petitioner needed a variance to build any camp on the island regardless of whether he had started construction before applying for the variance, due to the small, irregular, non-contiguous shape of the non-Buffer area on Phillips Island. Petitioner does not claim, as the Commission would have this Court believe, that it is a hardship for him to move the buildings from where they currently sit. Essentially, his claim is that his property has unique physical characteristics which entitle him to receive a variance in order to avoid an unwarranted hardship. The Board should have analyzed petitioner's request in this light and *not* in the context of a self-created hardship." *Lewis v. Dep't of Nat. Res.*, *supra*, 425–26; *See also: Chesley v. City of Annapolis*, 176 Md.App. 413, 439 (2007) (construing *Lewis*) (emphasis in original)<sup>5</sup>

Because the Board's previous 3-2 decision in AP-2025-008 was based solely on the conduct of the installer, the Board decided the appeal before reaching or exploring whether a variance was justified by the impeding subsurface rock encountered upon excavation.<sup>6</sup>

---

<sup>5</sup> It is significant in this appeal to note that, until the excavation was actually undertaken and the subsurface rock encountered, it was not known to the installer that a variance was needed.

<sup>6</sup> Similarly, in *Cromwell*, *supra*, the construction was commenced without first obtaining a variance, and was found to exceed a building height restriction in the local ordinance. As noted by Judge Cathell:

"Had there been evidence before the Board indicating that the subject property was peculiar or unusual and, thus, disproportionately affected by the height restriction, then we might have been able to conclude that the Board was correct." *Cromwell v. Ward*, *supra*, 726

Additionally, the conduct of an independent subcontractor installer is not attributable to the Applicant. Under Maryland law, a subcontractor is considered an independent contractor. Maryland law generally treats contractors and subcontractors as independent contractors:

"[I]f the worker's agreement is to perform the work 'according to his own means and methods free from control of his employer in all details connected with the performance of the work except as to its product or result' the worker is deemed to be an independent contractor and not an employee/servant. *Williams Construction Co. v. Bohlen*, 189 Md. 576, 580, 56 A.2d 694 (1948); *Gale v. Greater Washington Softball Umpires Assoc.*, 19 Md.App. 481, 311 A.2d 817 (1973)." *L. M. T. Steel Prods., Inc. v. Peirson*, 47 Md. App. 633, 636 (1981)

A decision from the Appellate Court of Connecticut illustrates the point:

"We conclude that the trial court's finding that the surveyor was hired by the defendant [applicant] was not supported by the record. In light of that conclusion and in the absence of any evidence that the surveyor was other than an independent contractor in control of his own means and methods of work, 'except as to the result of his work'; *Tianti v. William Raveis Real Estate, Inc.*, 231 Conn. 690, 697, 651 A.2d 1286 (1995); we conclude that the trial court incorrectly found that the hardship was self-created and then improperly applied the self-created hardship rule. We, therefore, reverse the judgment of the trial court and remand with direction to deny the appeal [to the trial court]." *Osborne v. Zoning Bd. of Appeals of Town of Guilford*, 41 Conn. App. 351, 354-55 (1996) (emphasis supplied)

In *Osborne, supra*, the applicant hired an architect to enlarge a summer residence. Before beginning construction, the architect engaged a surveyor to stake the corners of the proposed foundation. Before construction, the surveyor selected by the architect inadvertently staked the side line, resulting in a setback violation of 7 inches. The error was not discovered until construction was nearly completed. The surveyor applied for a variance.

At the hearing before the local zoning board, the surveyor testified that he was retained by the architect (and not by the applicant) to mark the offset for the building, and that the surveyor incorrectly placed one of the stakes seven inches closer to the side lot line than it should have been. Finding that the commencement of construction before obtaining a variance was an honest error on the part of the surveyor, and that granting the variance would not have an adverse effect, the zoning board granted the variance.

A neighbor appealed. On appeal from the zoning board, the trial judge denied the variance. The trial judge initially determined that the sole issue before it was whether the defendant's hardship was self-created, and found that the owner had employed the surveyor whose error caused the noncompliance. Based on that assumed employment relationship, the trial judge attributed the surveyor's error to the owner, and concluded that the hardship was self-created.

In reversing the decision of the trial judge, the Appellate Court found that, with respect to the relationship between the applicant and the surveyor, the surveyor was an independent contractor, and therefore, the owner did not create the hardship. Accordingly, the Appellate Court ruled that it was error on the part of the trial court to attribute the error of an independent contractor to the property owner. *Osborne v. Zoning Bd. of Appeals of Town of Guilford*, 41 Conn. App. 351, 354–55 (1996)<sup>7</sup>

As in *Osborne*, AutoZone had no involvement in the selection or supervision of the independent contractor who installed the sign, or in the means and methods of construction. Even if AutoZone were relying on hardship in this variance appeal, the acts of the independent installer would not be attributable to the Applicant.

#### *The Elements of Practical Difficulty in this Appeal*

##### *1(a). Strict Compliance Would Unreasonably Prevent the Use of the Property for a Permitted Purpose*

In this appeal, AutoZone is generally permitted under §§19.2(a) and 22.23 of the Ordinance to conduct a retail commercial business on the leased property and to have a related "use on premises" sign. Such signs are permitted under §22.23 as accessory uses. However, in view of §22.23(e) of the Ordinance, without variance relief, the existing sign would be required to be moved.

##### *1(b). Strict Compliance Would Render Conformance Unnecessarily Burdensome*

If the existing sign may not be permitted by the grant of a variance to remain in the location where currently constructed, it would be unnecessarily burdensome to the Applicant to remove the sign and relocate it 32 inches farther from the Sharpsburg Pike Right-of-way line.

---

<sup>7</sup> Although the decisions of the courts of Connecticut and other states are not binding in Maryland, they may offer a well-reasoned legal analysis.

*2(a). Denying the Variance Would Do Substantial Injustice to the Applicant*

Dimensional variance relief is included in the Ordinance to provide relief from the practical difficulty presented in this appeal. To deny relief from practical difficulty to which the Applicant is justly entitled would be a substantial injustice to the Applicant.

*2(b) A Lesser Relaxation than That Applied for Would Not Give Substantial Relief*

The extent of the requested variance is based on the actual location of the existing sign and its approximate distance from the right-of-way line of MD Rte. 65, with a reasonable margin of error.

*3(a). Granting the Variance Would Observe the Spirit of the Ordinance*

The Ordinance provides variance relief from practical difficulty on a case-by-case basis where the applicable criteria are present. There is no perceived detrimental effect or lack of compatibility of the sign at its present location on any adjacent or surrounding property.

*3(b). Granting the Variance Would Secure Public Safety*

There are no identifiable public safety issues identified in this variance application. Granting the variance would not impair visibility.

*3(c). Granting the Variance Would Secure Public Welfare*

There is no perceived public detriment associated with the present location of the sign. The appearance of the sign is consistent with the types of commercial uses in the HI zoning district.

*Section 25.6 Factors*

Pursuant to § 25.6 of the Ordinance, the Board applies the following guides and standards in considering whether to grant or deny variance relief:

*(a) The number of people residing or working in the immediate area concerned.*

Response: The HI zone along Sharpsburg Pike is predominately commercial in character. No adverse effects resulting from the adjustment of the location of the sign are perceived.

*(b) The orderly growth of a community.*

Response: The AutoZone use is appropriate in the HI zone. The purpose of the HI zone is described in the Ordinance:

Section 19.1. Purpose

The Highway Interchange District is established to provide suitable locations for commercial activities or light industrial land uses that serve highway travelers, provide goods and services to a regional population, or uses that have a need to be located near the interstate highway system to facilitate access by a large number of employees, or the receipt or shipment of goods by highway vehicles.

*(c) Traffic conditions and facilities.*

Response: The location of the sign does not adversely impact traffic conditions or facilities.

*(d) The effect of such use upon the peaceful enjoyment of people in their homes.*

Response: The current location of the sign has no effect on the peaceful enjoyment of people in their homes.

*(e) The conservation of property values.*

Response: The current location of the sign does not impact property values.

*(f) The effect of odors, dust, gas, smoke, fumes, vibrations, glare and noise upon the use of surrounding property values.*

Response: These enumerated adverse effects are not associated with the sign.

*(h) Decision of the courts.*

Response: The requested variance is supported by the decisions of the courts cited in this Memorandum.

*(i) The purpose of these regulations as set forth herein.*

Response: The Ordinance provides for the relief requested, based on the applicable practical difficulty standard.

*(j) Type and kind of structures in the vicinity where public gatherings may be held, such as schools, churches and the like.*

Response: There are no places where public gatherings are held in the vicinity of the sign.

Respectfully submitted,



---

William C. Wantz  
123 West Washington Street  
Hagerstown, MD 21740  
(301) 733-7972  
wantz@mac.com

Attorney for AutoZone Development LLC,  
Applicant





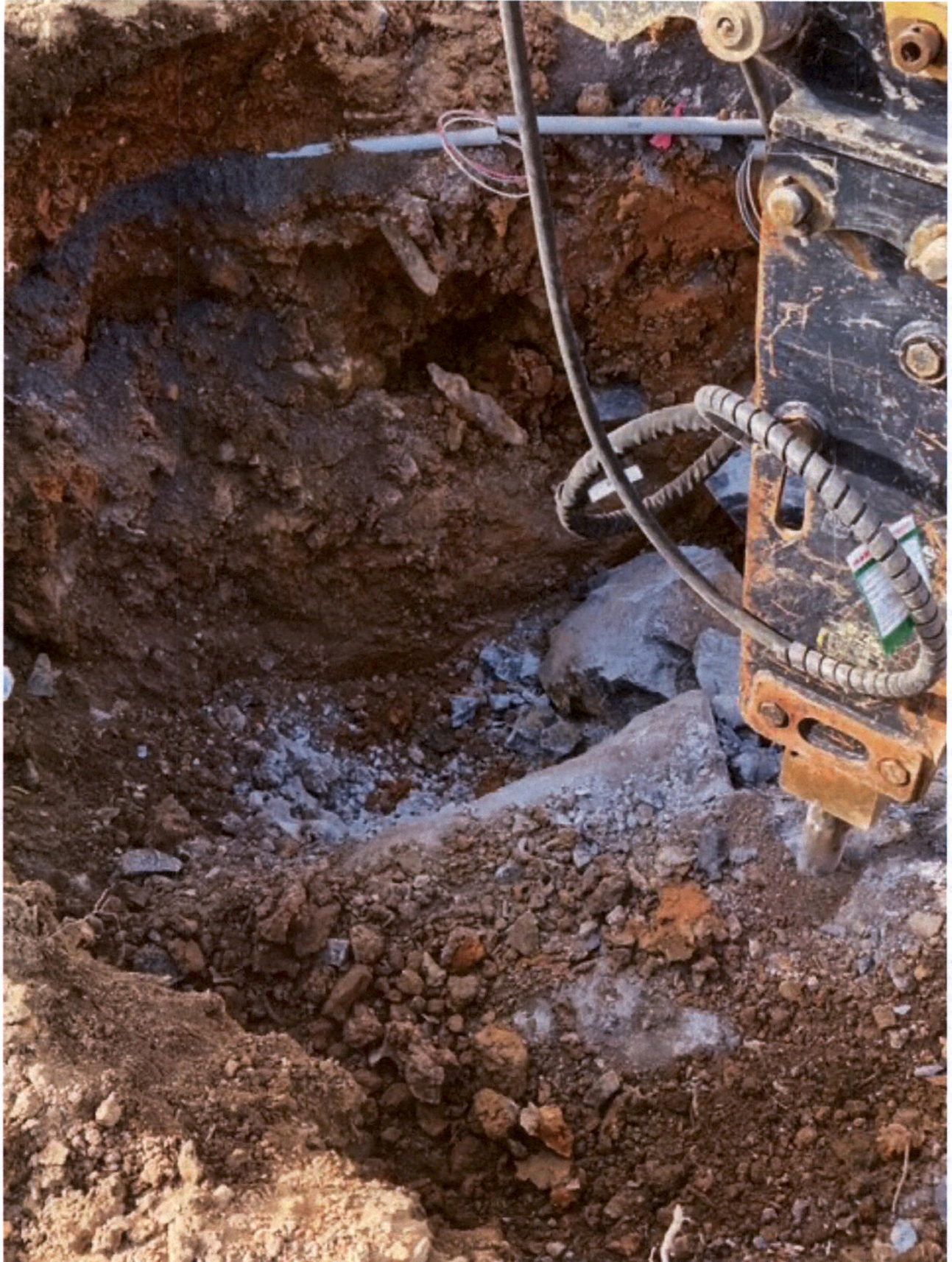

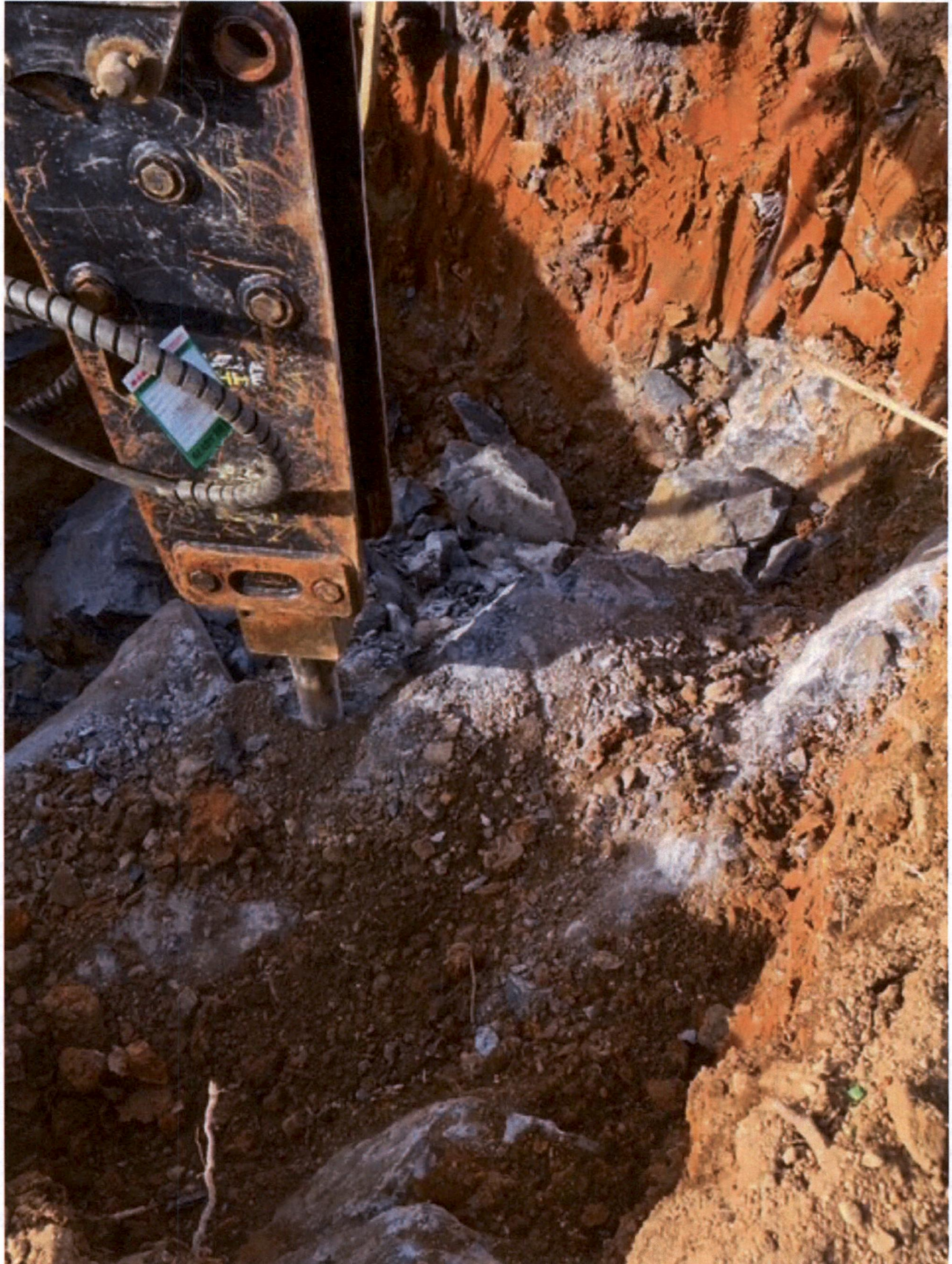





USE EXPERIENCED EXCAVATION CREW TO PERFORM FOUNDATION EXCAVATION.

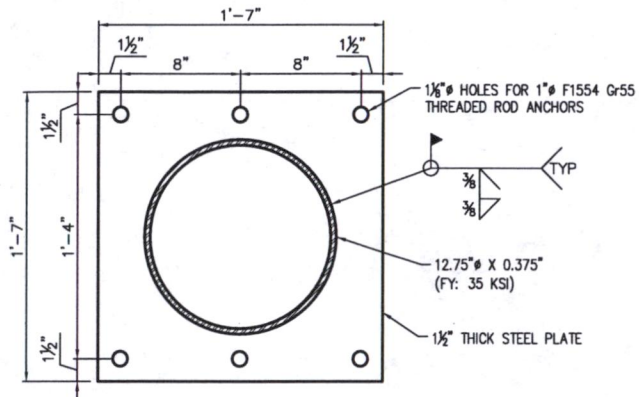

SECTION A  
SCALE: 1/2" = 1'-0"

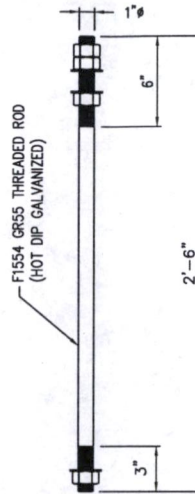

ANCHOR BOLT DETAIL  
SCALE: 1/2" = 1'-0"

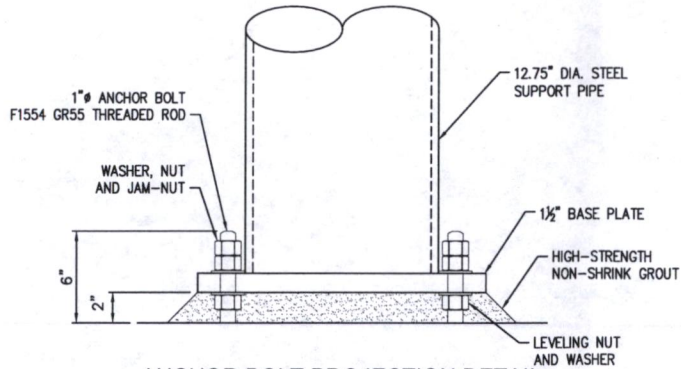

ANCHOR BOLT PROJECTION DETAIL  
SCALE: 1/2" = 1'-0"

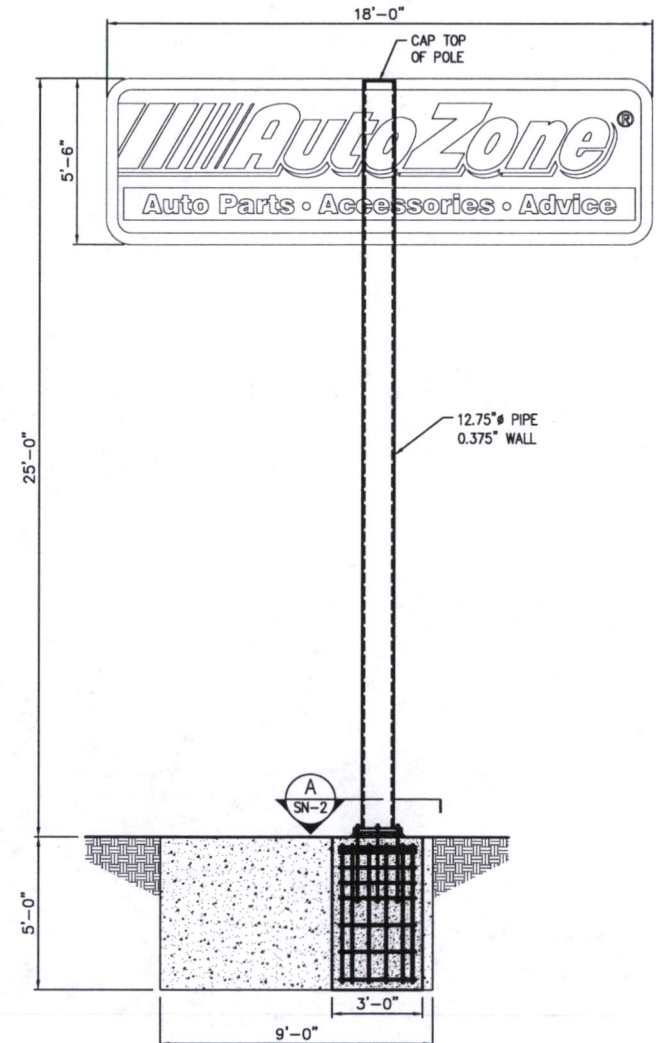

STRUCTURE ELEVATION  
SCALE: 1/4" = 1'-0"

Professional Certification: I hereby certify that these documents were prepared or approved by me, and that I am a duly licensed Professional Engineer under the State of Maryland, License No. 59875, expiration date September 11, 2026.



08/27/2025

Drawn	TBG
Checked	ERA
EE Job#	100z6860
Created	08/27/2025

**ELROD ENGINEERING**  
887 Seven Oaks Blvd., Suite 1010  
Smyrna, TN 37167  
615-890-9405

JONES SIGN  
1711 SCHEURING RD  
DE PERE, WI 54115

25'-0" PYLON RELOCATION

AUTOZONE  
10301 EZRA DRIVE  
HAGERSTOWN, MD 21740

No.	Date	Revision	By
---	---/---/---	---	---

SN-2

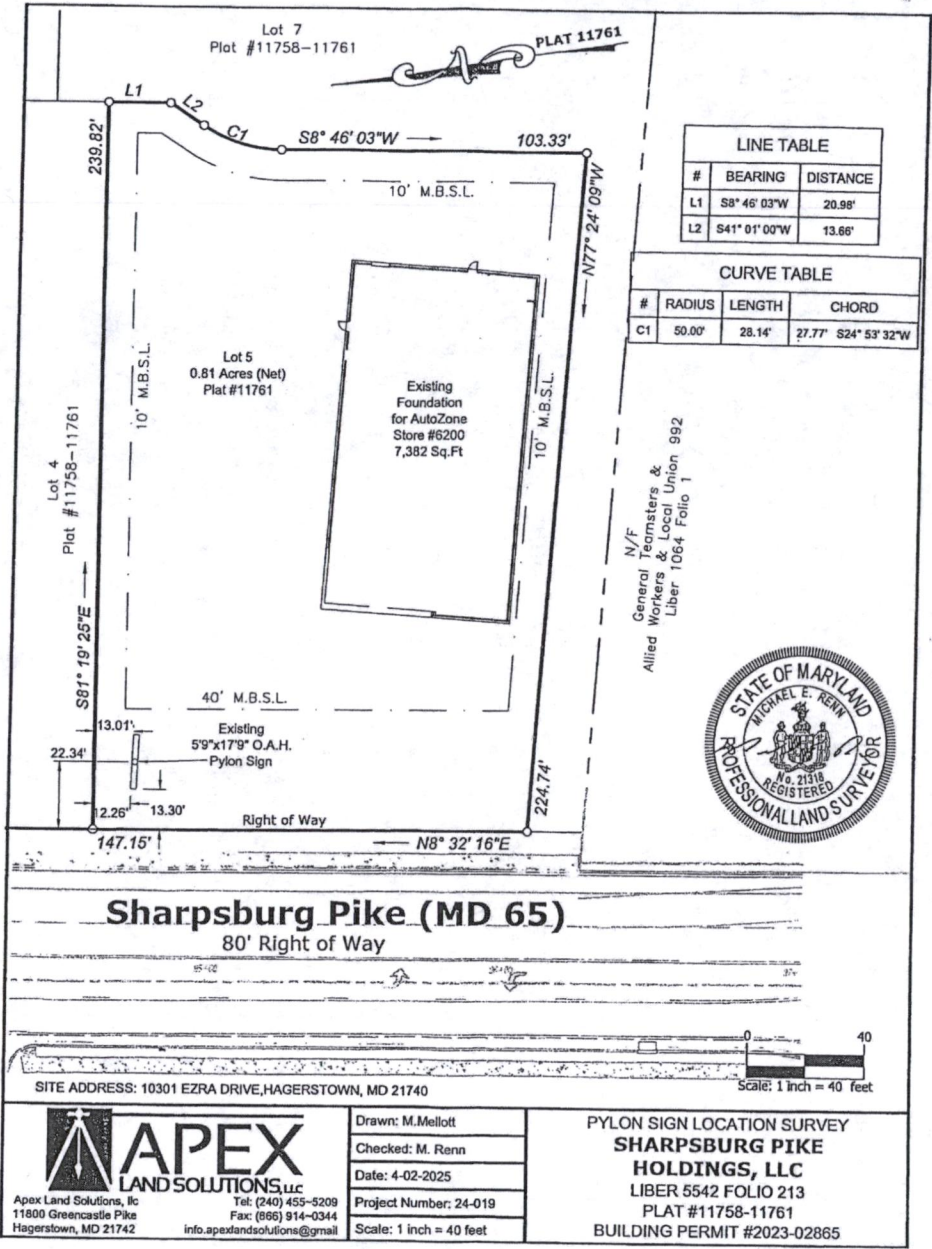

LINE TABLE		
#	BEARING	DISTANCE
L1	S8° 46' 03"W	20.98'
L2	S41° 01' 00"W	13.66'

CURVE TABLE			
#	RADIUS	LENGTH	CHORD
C1	50.00'	28.14'	27.77' S24° 53' 32"W

N/F  
General Teamsters &  
Allied Workers & Local Union 992  
Liber. 1064 Folio 1



**Sharpsburg Pike (MD 65)**  
80' Right of Way

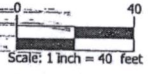

SITE ADDRESS: 10301 EZRA DRIVE, HAGERSTOWN, MD 21740

**APEX**  
LAND SOLUTIONS, LLC  
Apex Land Solutions, Inc  
11800 Greencastle Pike  
Hagerstown, MD 21742  
Tel: (240) 455-5209  
Fax: (866) 914-0344  
info.apexlandsolutions@gmail

Drawn: M. Mellott
Checked: M. Renn
Date: 4-02-2025
Project Number: 24-019
Scale: 1 inch = 40 feet

PYLON SIGN LOCATION SURVEY  
**SHARPSBURG PIKE**  
**HOLDINGS, LLC**  
LIBER 5542 FOLIO 213  
PLAT #11758-11761  
BUILDING PERMIT #2023-02865

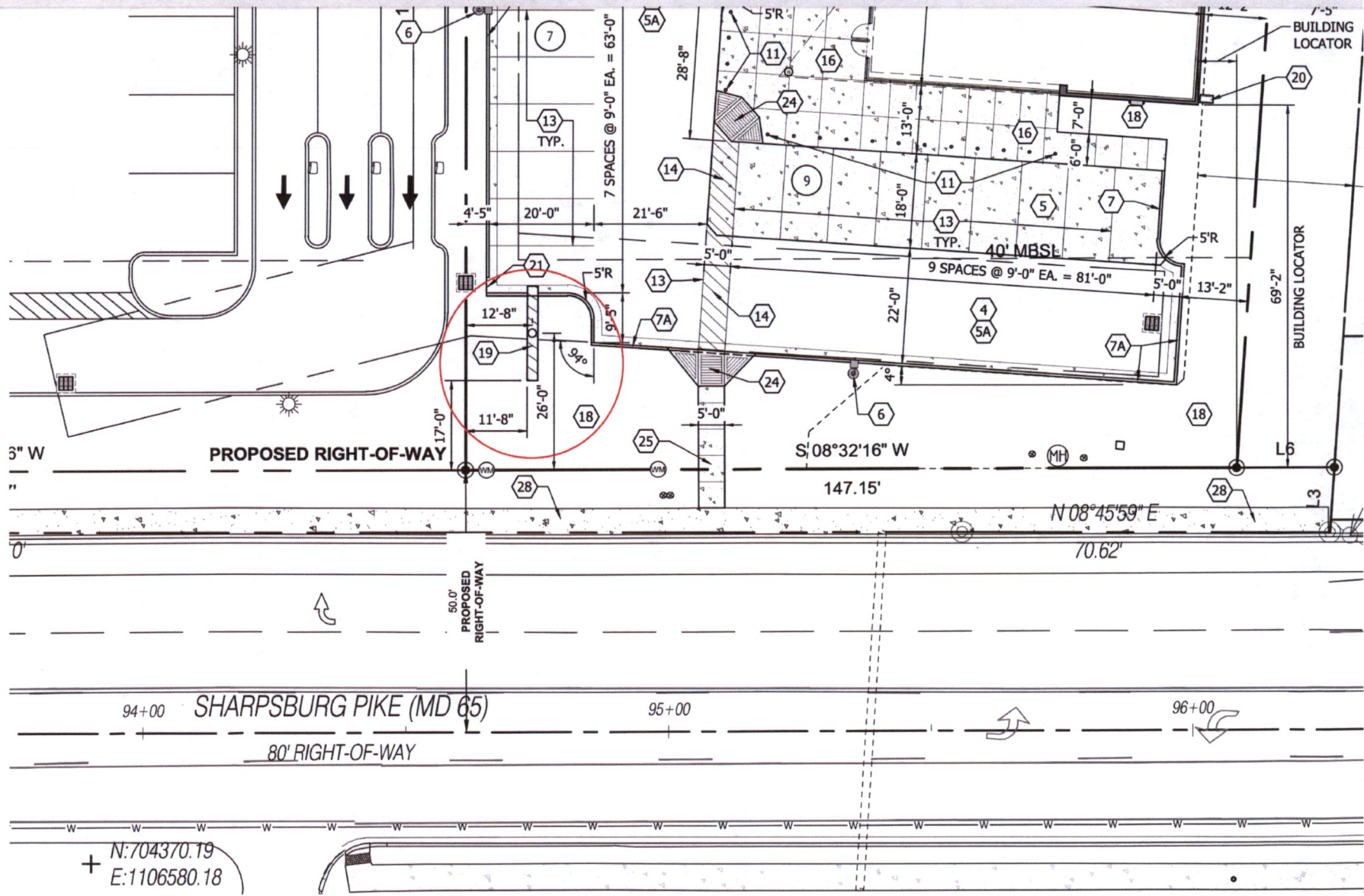

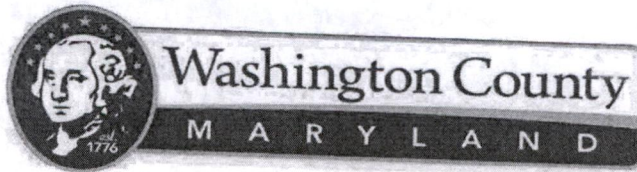

AUG 18 REC'D

**WASHINGTON COUNTY  
BOARD OF ZONING APPEALS**

August 12, 2025

Sharpsburg Pike Holding, LLC  
1741 Dual Highway  
Suite B  
Hagerstown, MD 21740

RE: *In the Matter of the Petition of Sharpsburg Pike Holding, LLC for Judicial Review of the Decision of the Board of Zoning Appeals for Washington County, Maryland, In the Case of The Denial of Board of Zoning Appeals for Washington County, Maryland, Case No. C-21-CV-25-000390 in the Circuit Court for Washington County, Maryland*

Dear: Sharpsburg Pike Holding LLC:

I am in receipt of the Petition in the above referenced appeal to the Circuit Court for Washington County, Maryland you filed.

Pursuant to Md. Rule 7-206(a), you are required to pay the costs of transcribing the testimony in Case No. AP2025-008, as the petitioner. This office is requesting a deposit of \$850.00. You will be notified of any balance or refund due. This office will not accept transcriptions provided by any other sources.

Please have the check made payable to "Washington County Treasurer" and mailed to my attention at the above address.

If you have any questions, please call me.

Sincerely,

Kathryn Rathvon  
Zoning Coordinator

cc: Zachary Kieffer, County Attorney

**BEFORE THE BOARD OF APPEALS  
FOR WASHINGTON COUNTY, MARYLAND**

**SHARPSBURG PIKE HOLDING, LLC**

\*

**Appeal No.: AP2025-008**

**Appellant**

\*

\*

\* \* \* \* \*

**OPINION**

Sharpsburg Pike Holding, LLC, (hereinafter "Appellant") requests a variance to reduce the required setback from the road right-of-way from 25 feet to 22.34 feet for an installed freestanding sign at the subject property. The subject property is located at 10301 Ezra Drive, Hagerstown, Maryland 21740 and is zoned Highway Interchange. The Board held a public hearing in this matter on May 28, 2025.

This appeal was heard pursuant to Article 25 of the Zoning Ordinance for Washington County and upon proper notice to the parties and general public as required.

**Findings of Fact**

Based upon the testimony given, all information and evidence presented, and upon a study of the specific property involved and the neighborhood in which it is located, the Board makes the following findings of fact:

1. Appellant is the owner of the subject property located at 10301 Ezra Drive, Hagerstown, Maryland. The subject property is zoned Highway Interchange.
2. The subject property consists of a newly constructed Auto Zone retail store on approximately .81 acres improved by a 7,382 square-foot retail building for an AutoZone store along Sharpsburg Pike.
3. An initial survey was completed and the location of the freestanding sign for the business was planned to meet the setback requirements.
4. During construction, the contractor discovered significant rock and the footer location for the sign moved to accommodate the topography issues. Although the

center of the footer location moved, the contractor believed that it still complied with the setback requirements.

5. Once the footers were poured for the sign, the County conducted an inspection and discovered that the location had moved inside the setback area. By the time this was discovered, the freestanding sign was completely installed.

6. There was no opposition presented to this appeal.

### Rationale

The Board has authority to grant a variance upon a showing of practical difficulty or undue hardship as set forth in Section 25.2 and 25.56 of the Ordinance.<sup>1</sup> "Practical Difficulty" may be found by the Board when: (1) strict compliance would unreasonably prevent the use of the property for a permitted purpose or render conformance unnecessarily burdensome; and (2) denying the variance would do substantial injustice to the applicant and a lesser relaxation than that applied for would not give substantial relief; and (3) granting the variance would observe the spirit of the Ordinance and secure public safety and welfare. Section 25.56(A).

Practical difficulty and undue hardship are typically the result of a property being unique. "'Uniqueness' of a property for zoning purposes requires that the subject property have an inherent characteristic not shared by other properties in the area, i.e., its shape, topography, subsurface condition, environmental factors, historical significance, access or non-access to navigable waters, practical restrictions imposed by abutting properties (such as obstructions) or other similar restrictions." *North v St. Mary's Cnty.*, 99 Md.App. 502, 514 (1994).

---

<sup>1</sup> "When the terms unnecessary hardship (or one of its synonyms) and practical difficulty are framed in the disjunctive ("or"), Maryland courts generally have applied the more restrictive hardship standard to use variances, while applying the less restrictive practical difficulty standard to area variances because use variances are viewed as more drastic departures from zoning requirements." *Belvoir Farms Homeowners Ass'n, Inc. v North*, 355 Md. 259, 276 n. 10 (1999) (citations omitted)

Appellant testified that the location of the sign inside the setback area was a complete accident due to movement of the footers during excavation. Although it acknowledged that the contractor should have known to check the measurements again, construction proceeded as is typical for freestanding signs. During her staff report, Ms. Rathvon noted that the County does not inspect for setback compliance until the footers are poured and typically the entire sign or structure is completed by the time any issue is discovered. That appears to be exactly what happened in this case.

However, the Board was not persuaded in this case. The Board raised concerns about the failure to re-measure once the contractor knew that the footer had floated and changed location. The Board considered the timeline of the process given by Ms. Rathvon, but there was still ample opportunity to confirm before proceeding with the remaining construction. Even though it was an honest mistake, it was preventable and self-created. On that basis, the Board is unable to find that a hardship or practical difficulty exists that is related to the inherent characteristics of the property and the application of the setback requirements thereto.

Accordingly, the request for A variance to reduce the required setback from the road right-of-way from 25 feet to 22.34 feet for an installed freestanding sign at the subject property is DENIED by a vote 3 to 2.

BOARD OF APPEALS

By: Tracie Felker, Chair

**Date Issued: June 27, 2025**

Notice of Appeal Rights

Any party aggrieved by a final order of the Authority in a contested case, whether such decision is affirmative or negative in form, is entitled to file a petition for judicial review of that order to the Circuit Court for Washington County within thirty (30) days of the date of the order.



WASHINGTON COUNTY BOARD OF ZONING APPEALS

747 Northern Avenue | Hagerstown, MD 21742-2723 | P:240.313.2430 | F:240.313.2431 | Hearing Impaired: 7-1-1

ZONING APPEAL

Property Owner: HBC LLC
216 Bennett Street
Mt. Pleasant SC 29464
Appellant: The W House of Hagerstown Foundation Inc
519 North Locust Street
Hagerstown MD 21740
Docket No: AP2026-013
Tax ID No: 27021239
Zoning: BL
RB Overlay: No
Zoning Overlay:
Filed Date: 04/22/2026
Hearing Date: 05/13/2026

Property Location: 18618 Crestwood Drive
Hagerstown, MD 21742

Description Of Appeal: Request for special exception on the basis that a transitional/sheltered care facility is functionally similar to the principal permitted use of an assisted living facility, nursing/convalescent home.

Appellant's Legal Interest In Above Property: Owner: No Contract to Rent/Lease: No
Lessee: No Contract to Purchase: Yes
Other:

Previous Petition/Appeal Docket No(s):

Applicable Ordinance Sections: Washington County Zoning Ordinance: Article 11, Section 11.3 (b)

Reason For Hardship:

If Appeal of Ruling, Date Of Ruling:

Ruling Official/Agency:

Existing Use: Previous Private School Proposed Use: Transitional Care Facility

Previous Use Ceased For At Least 6 Months: Date Ceased:

Area Devoted To Non-Conforming Use - Existing: Proposed:

I hereby affirm that all of the statements and information contained in or filed with this appeal are true and correct.

[Signature]
Appellant Signature

State Of Maryland, Washington County to-wit:

Sworn and subscribed before me this 23 day of April, 2026.

Nov 7 2029
My Commission Expires

[Signature]
Notary Public





WASHINGTON COUNTY BOARD OF ZONING APPEALS

747 Northern Avenue | Hagerstown, MD 21742-2723 | P:240.313.2430 | F:240.313.2431 | Hearing Impaired: 7-1-1

## AFFIDAVIT IN COMPLIANCE WITH SECTION 25.51(C)

Docket No: AP2026-013

State of Maryland Washington County, To Wit:

On 4/22/2026, before me the subscriber, a Notary of the public of the State and County aforesaid, personally appeared Jason Divelbiss and made oath in due form of law as follows:

Jason Divelbiss will post the zoning notice sign(s) given to me by the Zoning Administrator in accordance with Section 25.51(c) of the Washington County Zoning Ordinance for the above captioned Board of Appeals case, scheduled for public hearing on 05/13/2026, and that said sign(s) will be erected on the subject property in accordance with the required distances and positioning as set out in the attached posting instructions.

Sign(s) will be posted on 04/28/2026 and will remain until after the above hearing date.

Jason Divelbiss

Sworn and subscribed before me the day and year first above written.

Notary Public

Nov. 7, 2029

My Commission Expires

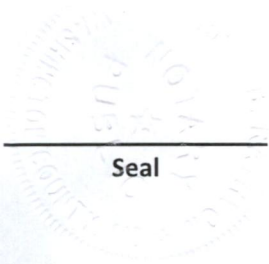

Seal



WASHINGTON COUNTY BOARD OF ZONING APPEALS

747 Northern Avenue | Hagerstown, MD 21742-2723 | P:240.313.2430 | F:240.313.2431 | Hearing Impaired: 7-1-1

## BOARD OF ZONING APPEALS

### ATTENTION!

### Posting Instructions

The premises MUST be posted in accordance with the following rules:

1. The sign must be posted a minimum of fourteen (14) days prior to the public hearing  
Section 25.51(c) Property upon which the application or appeal is concerned shall be posted conspicuously by a zoning notice no less in size than twenty-two (22) inches by twenty-eight (28) inches at least fourteen (14) days before the date of the hearing.
2. The sign must be placed on the property within ten (10) feet of the property line which abuts the most traveled public road.
3. The sign must be posted in a conspicuous manner not over six (6) feet above the ground level, and affixed to a sturdy frame where it will be clearly visible and legible to the public.
4. The sign shall be maintained at all times by the applicant until after the public hearing. If a new sign is needed or required, please contact the Plan Review Department at 240-313-2460.
5. An affidavit certifying the property will be posted for the minimum of fourteen (14) days prior to the public hearing date.

Proper posting of the sign will be spot checked by the Zoning Inspector. IF SIGN IS NOT IN COMPLIANCE, IT MAY RESULT IN RESCHEDULING OF THE HEARING.



BOARD OF ZONING APPEALS

747 Northern Avenue | Hagerstown, MD 21742 | P: 240.313.2430 | F: 240.313.2461 | Hearing Impaired: 7-1-1

WWW.WASHCO-MD.NET

Appeal for Special Exception

Appeal is hereby made for a special exception under the Washington County Zoning Ordinance as follows:

Location 18618 Crestwood Drive, Hagerstown, MD

Appellant's present legal interest in above property: (Check One)

Owner (Including Joint Ownership) Lessee Contract to rent/lease

Contract to Purchase Other

Use Proposed: Transitional or Sheltered Care Facility

Zoning Ordinance section and subsection(s) providing for proposed use: §11.3 within Article 11

(BL - Business, Local) zoning district

If filing functionally similar to a principal permitted use or special exception use, please list the use and describe the use similarities:

Provide Detailed Explanation on Separate Sheet

Has any previous petition or appeal involving this property been made to the Board?

Yes No

If yes, give docket number(s): (Unknown)

Additional comments, if any:

See Attached, Owner's Affidavit & Letter w/ supporting Exhibits

I hereby certify that I have, to the best of my knowledge, accurately supplied the information required for the above referenced appeal.

Signature of Appellant [Signature]

Email of Appellant jdivelbiss@divelbisslaw.com

The W House of Hagerstown Foundation, Inc. 519 N. Locust Street Hagerstown MD 21740

Address of Appellant Kylie Johnson, Exec. Director (301) 791-7826

Phone Number of Appellant Kjohnson@thehouse.org

This appeal form is to be used to assist the customer in gathering the information necessary to submit an application. However, the application shall be processed in person.

EXHIBIT 1



# Department of Planning & Zoning Owner's Representative Affidavit

This is to certify that The W House of Hagerstown Foundation, Inc. (the contract purchaser of our property) and its legal or civil engineering representative(s) is/are authorized to file with the Washington County Department of Planning and Zoning, an application for **Special Exception and/or Site Plan** with regard to the property located at 18618 & 18642 Crestwood Drive, Hagerstown, Md 21742 containing +/- 7.281 acres which is owned in fee simple by the undersigned.

PROPERTY OWNER:

HBC LLC, a Maryland limited liability company

Signed by:  
By: Steven Sumberg  
Name: Steven Sumberg  
Title: Managing Member  
Date: 4/9/2026

AUTHORIZED REPRESENTATIVE:

THE W HOUSE OF HAGERSTOWN  
FOUNDATION, INC., a Maryland corporation

DocuSigned by:  
By: Kylie Johnson  
Name: Kylie Johnson  
Title: Executive Director

April 22, 2026

Board of Zoning Appeals  
747 Northern Avenue  
Hagerstown, MD 21740

**Re: Special Exception – Transitional Care Facility  
+/- 7.3 ac. Property Located at 18618 Crestwood Drive, Hagerstown (former  
Hagerstown Business College / St. Maria Goretti facility) (TM 37; Parcel 803)**

Dear Board Members:

The Applicant, The W House of Hagerstown Foundation, Inc., a Maryland corporation, is the contract purchaser of the above referenced Property located at 18618 Crestwood Drive just behind the Dunkin' Donuts and other commercial uses along Pennsylvania Avenue. See attached SDAT Information Sheet and Aerial Photograph.

The Property is zoned BL (Business, Local) and is bounded on all sides by similarly zoned commercial property except for the Volvo manufacturing facility on the Property's west side which is zoned IG (Industrial, General). See attached.

In the County's Comprehensive Plan, the Property is designated for "Commercial" land-use which is described as follows:

Commercial policy areas are located primarily along significant transportation corridors such as the Interstates and State highways. Uses should be generally associated with retail sales and services for local and/or regional consumers.

*Opportunities should also be sought in this district to allow for mixed use buildings with residential uses.* (emphasis added)

The Property is currently improved with three (3) existing buildings; two (2) buildings previously used primarily for administrative office and classroom space by Hagerstown Business College, Purdue University Global and St. Maria Gorretti High School and a third (3<sup>rd</sup>) building with additional administrative office space, full kitchen, library and residential dormitory units.

To the best of Applicant's knowledge, the last Site Plan approved for the Property was in 2001 when the second (2<sup>nd</sup>) classroom building on the east side of the Property (closest to Pennsylvania Avenue) was added along with a new 66 space parking lot. See attached Sheet (SP-1) from the 2001 Site Plan submitted by Hagerstown Business College.

## Proposed Use

Applicant proposes to use the Property for residential and outpatient counseling services to assist women in the early stages of recovery from substance abuse. The list of non-medical clinical services to be offered by Applicant include individual counseling, group counseling, education and life skills development. Each individualized program is different, but on average lasts approximately ninety (90) days. Applicant has been operating at a different location in Washington County within the City of Hagerstown for over 30 years.

### *Improvements*

Applicant's present intent is to utilize the Property, the existing buildings, parking areas and other improvements "as-is" with the exception of making minor upgrades to the Property to improve safety and security, such as perimeter fencing, updated exterior lighting and a new fire suppression system in the dorm building, and general enhancements such as additional landscaping and exterior painting and cosmetic upgrades to the buildings. Additionally, several of the large interior spaces will be renovated and converted to three (3) additional residential dormitory units.

However, they request that any approval by the Board of the requested Special Exception permit, in the future, the construction of any additional buildings, building additions or other improvements to the Property (as may be permitted by the Zoning Ordinance and other applicable land-use rules and regulations) should the need arise.

### *Hours of Operation*

By its nature, as a residential treatment and recovery facility, Applicant's proposed use would operate 24 hours a day, 7 days per week. However, clinical hours would only be Monday - Thursday 8:00 a.m. to 6:00 p.m. and Friday 8:00 a.m. to 4:00 p.m.

### *Employees / Residents / Clients*

Staffing for the Applicant's proposed use will be provided by approximately twenty (20) total employees with approximately half those being full-time and half being part-time.

Maximum occupancy of the residential portions of the Property will not exceed forty (40) individuals and the number of out-patient clients that will come to the Property during the daytime hours of operation will be approximately 15 to 20.

### *Off-Street Parking*

As shown on the 2001 Site Plan, there are 271 regular parking spaces and 8 handicap accessible parking spaces located on the Property which is likely 10x more parking spaces than Applicant's use will require.

As per Section 22.1 of the Zoning Ordinance, the Off-Street Parking Requirement for

“Assisted Living Facility, Nursing/Convalescent Homes,” which presumably is how the proposed Special Exception use will be viewed, is 1 space per 3 patient beds, plus 1 space per main shift employee. Applying this requirement to Applicant’s proposed use, no more than 25 to 30 parking spaces would be required. In sum, there is more than adequate parking existing on the Property to accommodate the Applicant’s proposed use.

### **Application of Zoning Ordinance / Authority to Grant Special Exception**

In terms of the Zoning Ordinance, the Applicant’s proposed use of the Property meets the definition of a “Transitional or Sheltered Care Facility” (see attached) which falls into the category of “Residential Mental Health and Substance Abuse Facilities” (623220) in the North American Industry Classification System (NAICS) (see attached). Such facilities are considered a smaller sub-category of the larger class of uses known and referred to as “Nursing and Residential Care Facilities” (623) in the NAICS (see attached).

The BL (Business, Local) zoning district permits, as principally permitted uses, both “Offices and clinics, professional and business” and “Retirement, nursing and boarding homes.” See attached, relevant portions of the BL Zoning District (Art. 11).

The BL zoning district also allows uses that are not listed, but are “functionally similar to a listed principal permitted use by inclusion in the same 6-digit North American Industry Classification System (NAICS)” category.

Although a “Transitional or Sheltered Care Facility” (Zoning Ordinance) / “Residential Mental Health and Substance Abuse Facilities” (623220) (NAICS) may be, in practice and application, functionally similar to a Nursing Home, because it only shares the 3-digit 623 (Nursing and Residential Care Facilities) NAICS category code, it does not technically qualify under the Zoning Ordinance as “functionally similar” because it does not share the 6-digit category code.

As such, Applicant presents the within request for a Special Exception as per § 11.3 of Zoning Ordinance which permits Special Exception Uses in the BL zoning district for:

“Any other use that the Board finds is functionally similar to any principally permitted use or special exception listed in this Article. The Board shall not grant any special exception which is inconsistent with the purpose set forth for this District, nor which will materially or adversely affect the use of any adjacent or neighboring properties.”

### **Functional Similarity**

As indicated by being included within the broad category of “Nursing and Residential Care Facilities” (623) in the NAICS, the proposed “Transitional or Sheltered Care Facility” has numerous functional similarities to a “Nursing Home” which is a principal permitted use in the BL zoning district.

Specifically, both uses are mixed in nature having residential and commercial elements; both have full-time, around the clock staffing combined with more traditional business operating hours; the residential component of each use is temporary in nature; the residents in each type of facility are not likely to have vehicles, thus resulting in minimal daily traffic volume; there is a clinical element to both uses; and both uses are commonly found in “campus” like settings just as is present on the Property which has abundant green space, common courtyard area and other such elements that are therapeutic and welcoming to residents and outpatient clients.

### **Purpose of the BL Zoning District**

As stated in Article 11 of the Zoning Ordinance (see attached), the purpose of the BL (Business, Local) district is:

“to provide appropriate locations where the retail goods and services needed by a neighborhood population can be made available and can be served with adequate water and/or sewerage service meeting Health Department standards. Uses permitted in the Business, Local District should provide for the routine daily stopping needs of the nearby neighborhood residents and *be of an appropriate use intensity and scale to be compatible with the adequate and surrounding residential neighborhood.*”  
(emphasis added)

The BL zoning district’s emphasis on “appropriate use intensity and scale,” as well as the referenced to “mixed use buildings with residential uses” in the “Commercial” land-use classification in the Comp. Plan, clearly contemplate the presence and importance of residential uses within and around BL zoned areas.

The proposed use of the Property, having both residential and low-intensity commercial elements, is perfectly consistent with the purpose of the BL zoning district.

Further proof is provided by the fact that “Transitional or Sheltered Care Facilities” are principally permitted uses in the RB (Rural, Business) zoning district (see attached) which is essentially the rural area equivalent to the urban area BL zoning.

### **Proposed Use Will Not Materially or Adversely Affect the Use of Any Adjacent or Neighboring Properties**

In Maryland, a use permitted by Special Exception carries with it a presumption of compatibility with the surrounding area.

As the Courts have guided, to overcome this presumption there must be facts or circumstances demonstrating that the proposed use will have greater adverse effects at THIS location than on any other property with the same BL zoning.

In this case, there are no such facts or circumstances. To the contrary, this Property seems particularly suited for the proposed Special Exception use given its size; the character of the

surrounding properties; the Property's location somewhat off the beaten path yet directly accessible from Pennsylvania Avenue; and the suitability of the existing buildings, parking areas and campus style amenities.

### **Conclusion**

I look forward to discussing the particular facts and circumstances of the proposed use and this request for Special Exception and variances with you at the Board's next regularly scheduled hearing.

Very truly yours,  
**JD LAW COMPANY, INC.**

A handwritten signature in blue ink, appearing to read 'J. Divelbiss', with a large, stylized initial 'J' on the left and a long horizontal flourish extending to the right.

Jason M. Divelbiss  
*Attorney at Law*

Email: [jdivelbiss@divelbislaw.com](mailto:jdivelbiss@divelbislaw.com)

## SDAT Information Sheet

## Real Property Data Search ( )

## Search Result for WASHINGTON COUNTY

<a href="#">View Map</a>	<a href="#">View GroundRent Redemption</a>	<a href="#">View GroundRent Registration</a>	
<b>Special Tax Recapture: None</b>			
<b>Account Number:</b>	District - 27 Account Identifier - 021239		
<b>Owner Information</b>			
<b>Owner Name:</b>	HBC LLC	<b>Use:</b> COMMERCIAL	
<b>Mailing Address:</b>	216 BENNETT ST MT PLEASANT SC 29464-	<b>Principal Residence:</b> NO	
		<b>Deed Reference:</b> /01385/ 00550	
<b>Location &amp; Structure Information</b>			
<b>Premises Address:</b>	18618 CRESTWOOD DR HAGERSTOWN 21742-0000	<b>Legal Description:</b> 7.281 ACRES 18618&18642 CRESTWOOD DR	
<b>Map:</b>	<b>Grid:</b>	<b>Parcel:</b>	
0037	0005	0803	
<b>Neighborhood:</b>	<b>Subdivision:</b>	<b>Section:</b>	
10000.22	0000		
<b>Block:</b>	<b>Lot:</b>	<b>Assessment Year:</b>	
		2025	
<b>Plat No:</b>	<b>Plat Ref:</b>		
<b>Town:</b> None			
<b>Primary Structure Built</b>	<b>Above Grade Living Area</b>	<b>Finished Basement Area</b>	
1992	48,586 SF		
<b>Property Land Area</b>	<b>County Use</b>		
317,160 SF			
<b>StoriesBasementType</b>	<b>ExteriorQualityFull/Half BathGarageLast Notice of Major Improvements</b>		
MULTI-PURPOSE SCHOOL BUILDING/	C3	2001	
<b>Value Information</b>			
	<b>Base Value</b>	<b>Value</b>	<b>Phase-in Assessments</b>
		As of	As of
		01/01/2025	07/01/2024
<b>Land:</b>	2,548,000	2,548,000	
<b>Improvements</b>	1,174,800	1,183,000	
<b>Total:</b>	3,722,800	3,731,000	3,722,800
<b>Preferential Land:</b>	0	0	3,725,533
<b>Transfer Information</b>			
<b>Seller:</b> O/E LEARNING INC	<b>Date:</b> 01/27/1998	<b>Price:</b> \$1,925,000	
<b>Type:</b> NON-ARMS LENGTH OTHER	<b>Deed1:</b> /01385/ 00550	<b>Deed2:</b>	
<b>Seller:</b> H B C ASSOCIATES	<b>Date:</b> 08/04/1988	<b>Price:</b> \$1,960,000	
<b>Type:</b> ARMS LENGTH IMPROVED	<b>Deed1:</b> /00885/ 00339	<b>Deed2:</b>	
<b>Seller:</b> AGNITA SCHREIBER	<b>Date:</b> 03/11/1985	<b>Price:</b> \$225,000	
<b>Type:</b> ARMS LENGTH IMPROVED	<b>Deed1:</b> /00780/ 00612	<b>Deed2:</b>	
<b>Exemption Information</b>			
<b>Partial Exempt Assessments:</b>	<b>Class</b>	07/01/2024	07/01/2025
<b>County:</b>	000	0.00	
<b>State:</b>	000	0.00	
<b>Municipal:</b>	000	0.0010.00	0.0010.00
<b>Special Tax Recapture: None</b>			
<b>Homestead Application Information</b>			
<b>Homestead Application Status:</b> No Application			
<b>Homeowners' Tax Credit Application Information</b>			
<b>Homeowners' Tax Credit Application Status:</b> No Application			
<b>Date:</b>			

## Aerial Photograph

ill your projects in Google Earth.



## Zoning Map

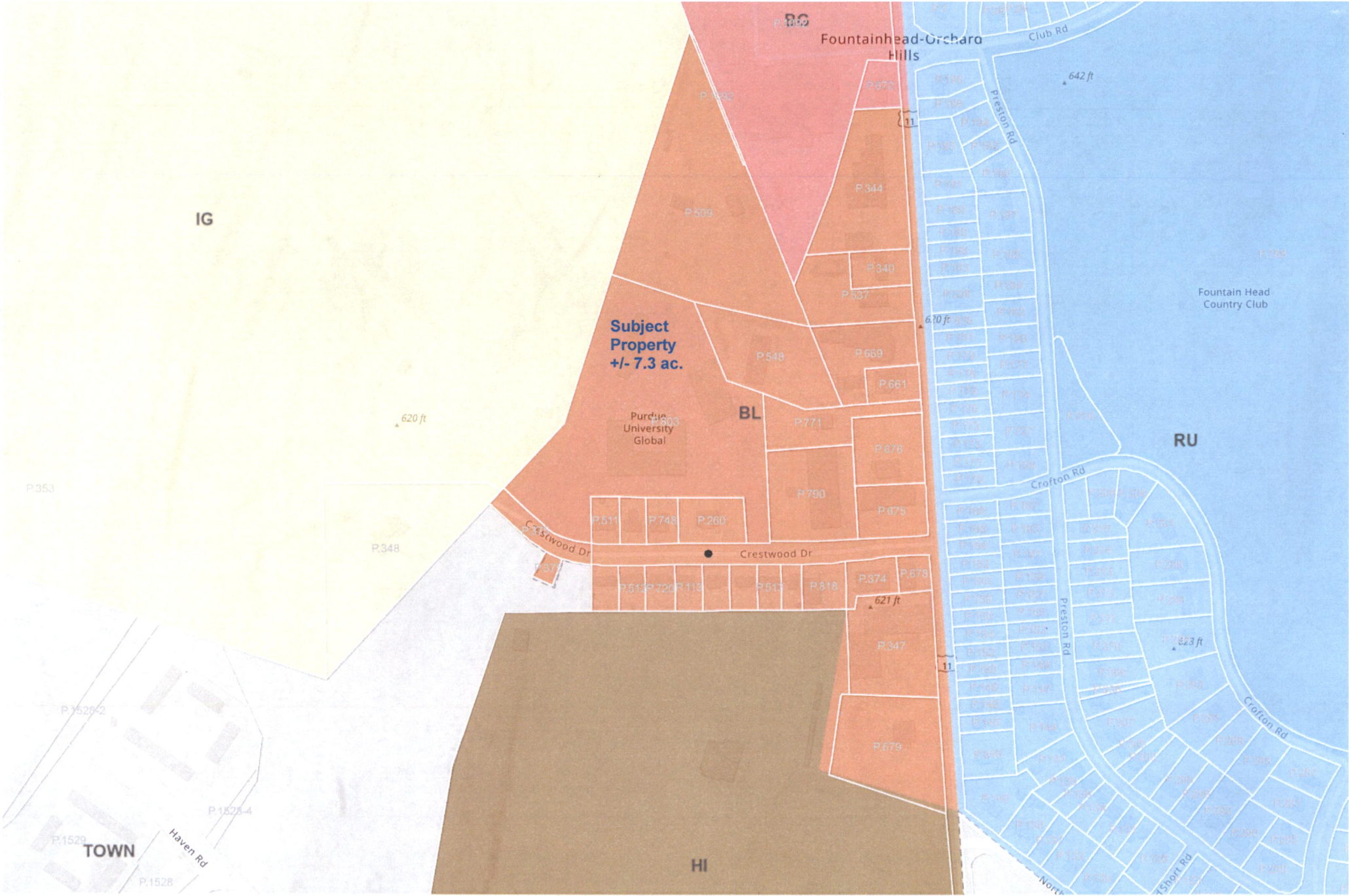

IG

BC  
Fountainhead-Orchard Hills

**Subject Property +/- 7.3 ac.**

Purdue University Global

BL

RU

HI

Fountain Head Country Club

P.353

620 ft

P.348

Crestwood Dr

Crestwood Dr

670 ft

621 ft

642 ft

623 ft

P.1528-2

P.1528-4

P.1529

TOWN

Haven Rd

P.1528

Club Rd

Preston Rd

Crofton Rd

Preston Rd

Crofton Rd

North

Sport Rd

2001 Site Plan

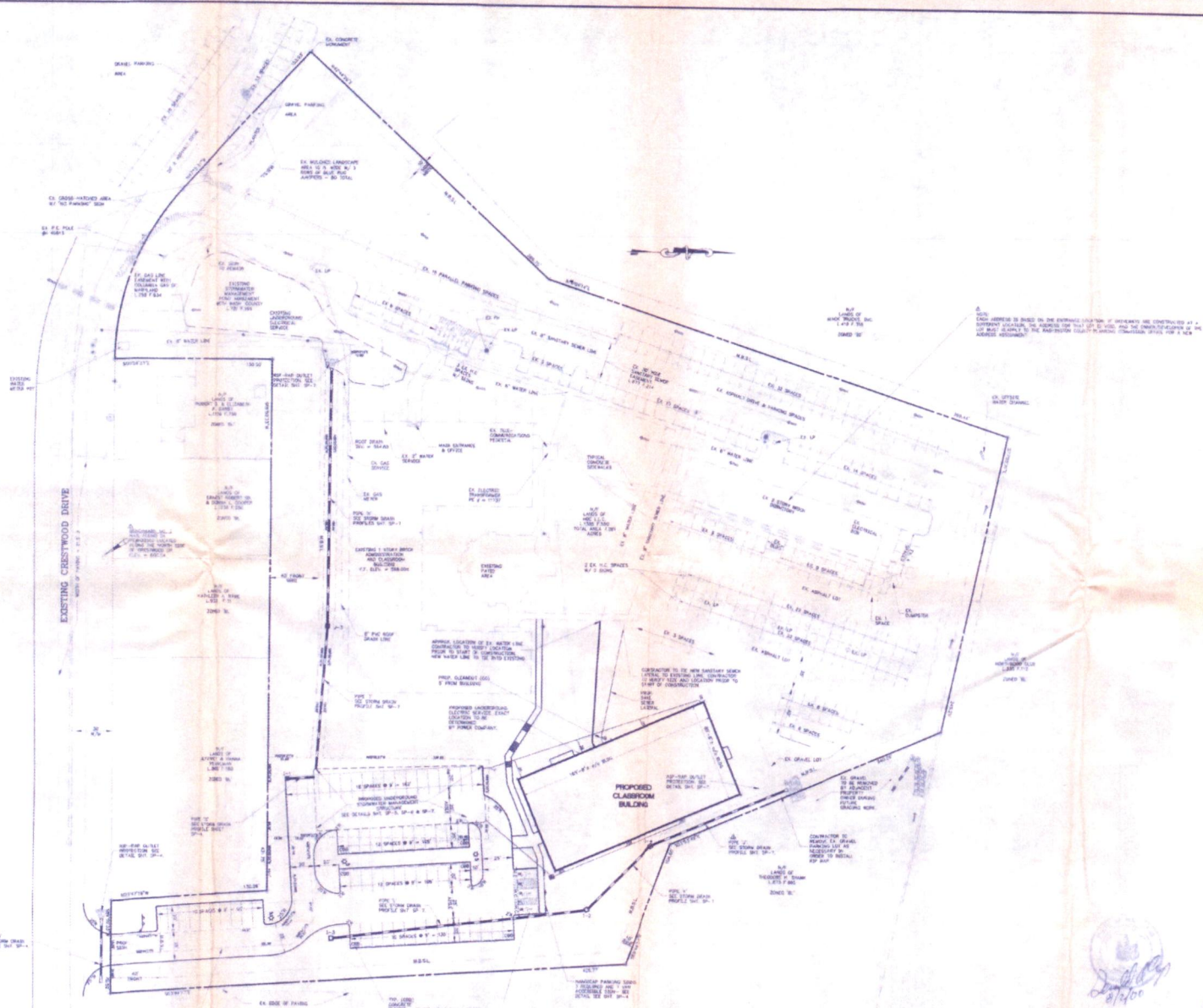

OVERALL SITE PLAN  
 FOR  
**HAGERSTOWN BUSINESS COLLEGE**  
 SITUATED ALONG THE NORTH SIDE OF CRESTWOOD DRIVE, WEST OF PENNSYLVANIA AVENUE  
 HAGERSTOWN COUNTY, MARYLAND

**GERALD A. CUMP & ASSOCIATES, INC.**  
**ENGINEERS & SURVEYORS**  
 121 East Baltimore Street  
 Hagerstown, Maryland 21740  
 Phone: (301) 733-2211

DATE	SCALE	JOB NO.	DRAWN BY	SHEET NO.
June 2, 2000	1"=40'	176A-HBC	SP-1	SP-1

**“Transitional or Sheltered Care Facility”**  
**(Zoning Ordinance Definition)**

**Tourism Entertainment Facility:**

A facility for the traveling public designed to their amusement. This would include such things as: amusement parks and water parks. Interpretive centers involved with education and teaching would not fall into this category.

**Trade and Technical Institutions:**

An educational facility established for the training of students in specific job skills. For example: electronic repair, the operation of machinery and cosmetology. Such facility may not exceed thirty (30) acres where permitted by special exception.

**Transitional or Sheltered Care Facility:**

A facility, including half-way houses, providing 24 hr/day care of persons with special needs, which provides food and shelter, and may also provide some combination of personal care, transportation, physical, social, or psychological therapy and counseling to assist persons in overcoming physical or emotional problems.

**Travel Trailer:<sup>256</sup>****Travel Trailer Park:**

A plot of ground designed for and having the required facilities for servicing travel trailers and similar vehicles and campers.

**Truck Stop:**

A structure or land used or intended to be used primarily for the sale of fuel for trucks and, usually long-term truck parking, incidental service or repair of trucks, overnight accommodations, or restaurant facilities open to serve the general public; or a group of facilities consisting of such a use and attendant eating, repair, sleeping or truck parking facilities. As used in this definition, the term "trucks" does not include any vehicle whose maximum gross weight is 10,000 pounds or less, as rated by the State Motor Vehicle Administration.

**Truck Terminal:**

A structure or land used or intended to be used primarily: (a) to accommodate the transfer of goods or chattels from trucks or truck-trailers to other trucks or truck-trailers or to vehicles or storage containers of other types, such as land-sea containers, in order to facilitate the transportation of such goods or chattels; or (b) for parking or storage of trucks, truck trailers, trailers, or in-transit mobile storage containers, such as land-sea containers.

A truck terminal may include loading and unloading platforms, warehouse facilities for temporary storage of goods in transit, reservoir parking for trucks and truck-trailers waiting to be loaded or unloaded and related business offices.

<sup>256</sup>

Revision 16, definition deleted 12/1/09, eff. 2/1/2010 (RZ-09-003/ORD-09-10)

**“Residential Mental Health and Substance Abuse Facilities”**  
**(NAICS Code - 623220)**

## **623220 - Residential Mental Health and Substance Abuse Facilities**

This industry comprises establishments primarily engaged in providing residential care and treatment for patients with mental health and substance abuse illnesses. These establishments provide room, board, supervision, and counseling services. Although medical services may be available at these establishments, they are incidental to the counseling, mental rehabilitation, and support services offered. These establishments generally provide a wide range of social services in addition to counseling.

### **Illustrative Examples:**

Alcoholism or drug addiction rehabilitation facilities  
(except licensed hospitals)

Psychiatric convalescent homes or hospitals

Mental health halfway houses

Residential group homes for the emotionally disturbed

"Nursing and Residential Care Facilities"  
(NAICS Code - 623)

## **623 - Nursing and Residential Care Facilities**

Industries in the Nursing and Residential Care Facilities subsector provide residential care combined with either nursing, supervisory, or other types of care as required by the residents. In this subsector, the facilities are a significant part of the production process, and the care provided is a mix of health and social services with the health services being largely some level of nursing services.

BL Zoning District (Art. 11)

## ARTICLE 11 "BL" BUSINESS, LOCAL DISTRICT<sup>97</sup>

### Section 11.0 Purpose

The purpose of the Business, Local District is to provide appropriate locations where the retail goods and services needed by a neighborhood population can be made available and can be served with adequate water and/or sewerage service meeting Health Department standards.

Uses permitted in the Business, Local District should provide for the routine daily stopping needs of the nearby neighborhood residents and be of an appropriate use intensity and scale to be compatible with the adjacent and surrounding residential neighborhood.

Commercial goods and services that serve a regional population or, due to inherent characteristics, are incompatible with residential development are inappropriate and not permitted in the Business, Local District.

All new development in the Business, Local District should be served by public water and sewer facilities approved by the Washington County Health Department.

The following regulations and applicable regulations contained in other articles shall apply in the "BL" Business, Local District.

### Section 11.1 Principal Permitted Uses<sup>98</sup>

- (a) Local retail goods and service shops, including:
  - Alcoholic beverage package stores.
  - Antique shops.
  - Appliance stores.
  - Automobile accessory.
  - Bakery shops (retail production and sales only).
  - Banks, savings and loans institutions.
  - Banquet/Reception Facilities
  - Beauty and barber shops.
  - Candy stores.
  - Clothing stores.
  - Dairy products stores.
  - Dress or millinery shops.
  - Drug stores.
  - Dry goods or variety stores.
  - Florist or garden shops.
  - Food and grocery stores.
  - Fruit or vegetable stores.
  - Furniture and upholstering stores.

<sup>97</sup> Revision 17, Article 11 deleted and replaced, 4/17/12, eff. 7/1/12 (RZ-10-001/ORD-2010-07)

<sup>98</sup> Revision 17, Section 11.1(a) amended 4/23/13 by adding Banquet/Reception Facilities (RZ-12-002/ORD-2013- 13)

Gift or jewelry shops.  
Hardware stores.  
Laundromats.  
Laundry or dry cleaning establishments and pick-up stations.  
Meat Markets.  
Photographic studios.  
Printing, blue printing, photocopying, and similar reproduction services limited to a maximum 15,000 square feet of floor space.  
Produce stands.  
Radio, television or electronic repair shops.  
Restaurants and lunch rooms.  
Shoe repair shops.  
Specialty shops.  
Sporting goods or hobby shops.  
Stationery stores.  
Tailor establishments.  
Taverns.  
Taxi stands.  
Temporary or Seasonal Retail - provided that the area devoted to the use be limited to less than 2,500 sq. ft. and that the use on the premises occurs for at least 30 days and does not exceed 9 months within a calendar year.

- (b) Neighborhood shopping centers containing any principal permitted or approved special exception use, as defined in Article 28A and Section 11.6(h).
- (c) Funeral establishments.
- (d) Offices and clinics, professional and business.
- (e) Retirement, nursing, and boarding homes.
- (f) Schools for performing and visual arts.
- (g) Community meeting halls.
- (h) Self-Storage mini-warehouses excluding outside storage or outside uses.
- (i) Libraries.
- (j) When it can be determined that an unlisted use is functionally similar to a listed principal permitted use by inclusion in the same 6-digit North American Industry Classification System (NAICS), the use may also be permitted in the Business, Local District as if it were listed as a principal permitted use herein.

If a proposed use is not listed and cannot be determined to be functionally similar in character to a listed use by reference to its 6-digit NAICS Code, the use is not permitted in the Business, Local District except when

approved by the Board of Appeals as a special exception as stated in Section 11.3.

- (k) Structures and uses existing prior to assignment of the current Business, Local District that are not listed as principal permitted uses are considered non-conforming uses and are permitted subject to the guidelines governing such uses in Section 4.3.

Section 11.2 Accessory Uses.

- (a) Uses and structures customarily accessory and incidental to any permitted principal use or authorized conditional use, including a single-family dwelling unit in the same building with a principal use.

Section 11.3 Special Exception Uses (Requiring Board Authorization After Public Hearing)

- (a) Public Utility Buildings, Structures or uses not considered essential utility equipment, as defined in Article 28A.
- (b) Any other use that the Board finds is functionally similar to any principally permitted use or special exception listed in this Article. The Board shall not grant any special exception which is inconsistent with the purpose set forth for this District, nor which will materially or adversely affect the use of any adjacent or neighboring properties.
- (c) Places of worship.

Section 11.4 Height Regulations

No structure shall exceed twenty-five (25) feet in height, except as provided in Section 23.4.

Section 11.5 Lot Area, Lot Width, and Yard Setback Requirements

The following minimum requirements shall be observed, subject to the modified requirements in Article 23.

Use	Lot Area	Lot Width	Lot Area Per family	Front Yard Depth	Side yard (Width Each Side Yard)	Rear Yard Depth
Principal Permitted or Accessory Uses				25 ft.	10 ft.*	10 ft.*

\*Where adjoining any RR, RT, RS, RU, or RM District, not less than twenty-five (25) feet.

Rural Area Land-Use Chart

A(R)-Agriculture (Rural)  
 EC-Environmental Conservation  
 P-Preservation  
 RV-Rural Village  
 RB-Rural Business  
 IM-Industrial Mineral

LAND USES	A(R)	EC	P	RV	RB	IM	Intensity of Use
Riding academies, livery stables, subject to the distance requirements specified in Section 4.9	P	P	P	P	P	N	MODERATE
Taxidermy Service	P	P	P	P	P	N	LOW
Theaters	N	N	N	N	P	N	HIGH
Theaters, Outdoor; provided a minimum of five (5) acres is maintained; and provided such use shall be subject to three (3) times the distance requirements of Section 4.9	N	N	N	N	P	N	HIGH
Trap, skeet, rifle, or archery ranges, including gun clubs; provided such use shall be five (5) times the distance requirements specified in Section 4.9 and all safety standards of county, state and federal agencies are observed	SE	SE	SE	N	P	N	HIGH
Travel trailer parks/Camp grounds, subject to the provisions of Section 22.5 and provided such use shall be three (3) times the distance requirements specified in Section 4.9	SE	N	N	SE	P	N	HIGH
<b>F. Construction</b>							
Surface grading, removal of top soil, shale or similar material in preparing the property for development; but not including open pit quarrying or mineral processing on site; subject to the performance standards in Section 4.12. A grading plan containing the information required in Section 15.3 showing the existing and proposed surface contours and providing for the re-vegetation of the property shall be submitted to the Planning Commission for approval	P	P	P	P	N	N	N/A
<b>G. Educational Services</b>							
Public or private college, trade and technical institutions	SE	N	N	N	P	N	HIGH
Schools – public or private – elementary through high	P	P	P	P	N	N	HIGH
<b>H. Finance and Insurance</b>							
<b>Banks and financial institutions</b>	N	N	N	N	P	N	MODERATE
<b>I. Health Care and Social Assistance</b>							
Assisted Living Facilities	N	N	N	N	P	N	MODERATE
Clinics with or without a pharmacy	N	N	N	N	P	N	MODERATE
Comprehensive Care Facilities	N	N	N	N	P	N	HIGH
Day-Care, Adult & Child centers, including Nursery Schools.	N	N	N	N	P	N	MODERATE
Day-care, In home Family/Child Care Facilities	P	P	P	P	N	N	N/A

P-Permitted  
 SE-Special Exception  
 A-Accessory  
 N-Not Permitted

A(R)-Agriculture (Rural)  
 EC-Environmental Conservation  
 P-Preservation  
 RV-Rural Village  
 RB-Rural Business  
 IM-Industrial Mineral

LAND USES	A(R)	EC	P	RV	RB	IM	Intensity of Use
Nursing/Convalescent Homes.	N	N	N	N	P	N	MODERATE
Transitional or Sheltered Care Facility, not to include Assisted Living Facilities.	N	N	N	N	P	N	MODERATE
<b>J. Housing</b>							
Dwelling unit in conjunction with a principal non-residential use	SE	SE	SE	SE	P	N	LOW
Dwellings, semi-detached	SE	SE	SE	P	N	N	N/A
Dwellings, single family	P	P	P	P	N	N	N/A
Dwellings, two-family	P	P	P	P	N	N	N/A
Home, occupation	A	A	A	A	N	N	N/A
Home, resident business	SE	SE	SE	SE	N	N	N/A
Mobile Homes	P	P	P	N	N	N	N/A
Model Homes	P	P	P	P	N	N	N/A
Temporary residential sales office	P	P	P	P	N	N	N/A
<b>K. Manufacturing<sup>10</sup></b>							
Abattoirs, slaughterhouses, stockyards	N	N	N	N	P	N	HIGH
Brewery, Farm with a valid Class 8 manufacturing license	P	P	P	P	P	N	MODERATE
Brewery, Commercial with a valid Class 5 manufacturing license	SE	SE	SE	SE	P	N	MODERATE
Carpentry or woodworking shops	SE	SE	SE	SE	P	N	HIGH
Concrete and ceramic products manufacture, including ready-mixed concrete plants	N	N	N	N	P	P	HIGH
Flour mill, grain milling or drying	N	N	N	N	P	N	HIGH
Food processing and packing plants; provided such use shall be located two (2) times the distance requirements specified in Section 4.9	SE	SE	SE	N	P	N	HIGH
Grain elevators, grain bins, and feed mills, primarily for wholesale use.	P	SE	SE	N	P	N	MODERATE
Machine Shops	SE	SE	SE	SE	P	N	MODERATE
Recycling facilities	N	N	N	N	P	N	HIGH
Sawmills & Lumber Drying	SE	SE	SE	N	P	N	MODERATE
Sawmills, Temporary	P	P	P	N	N	P	HIGH
Wind mill farms	SE	SE	SE	SE	N	N	N/A
Wineries, Farm with a valid Class 4 manufacturing license	P	P	P	P	P	N	MODERATE
Wineries, Commercial with a valid Class 3 manufacturing license	SE	SE	SE	SE	P	N	MODERATE

<sup>10</sup> Revision 17 Table 3.3(1)K. amended 4/23/13 (RZ-12-002/ORD-2013-13)

P-Permitted  
 SE-Special Exception  
 A-Accessory  
 N-Not Permitted